

MODEL# 8971

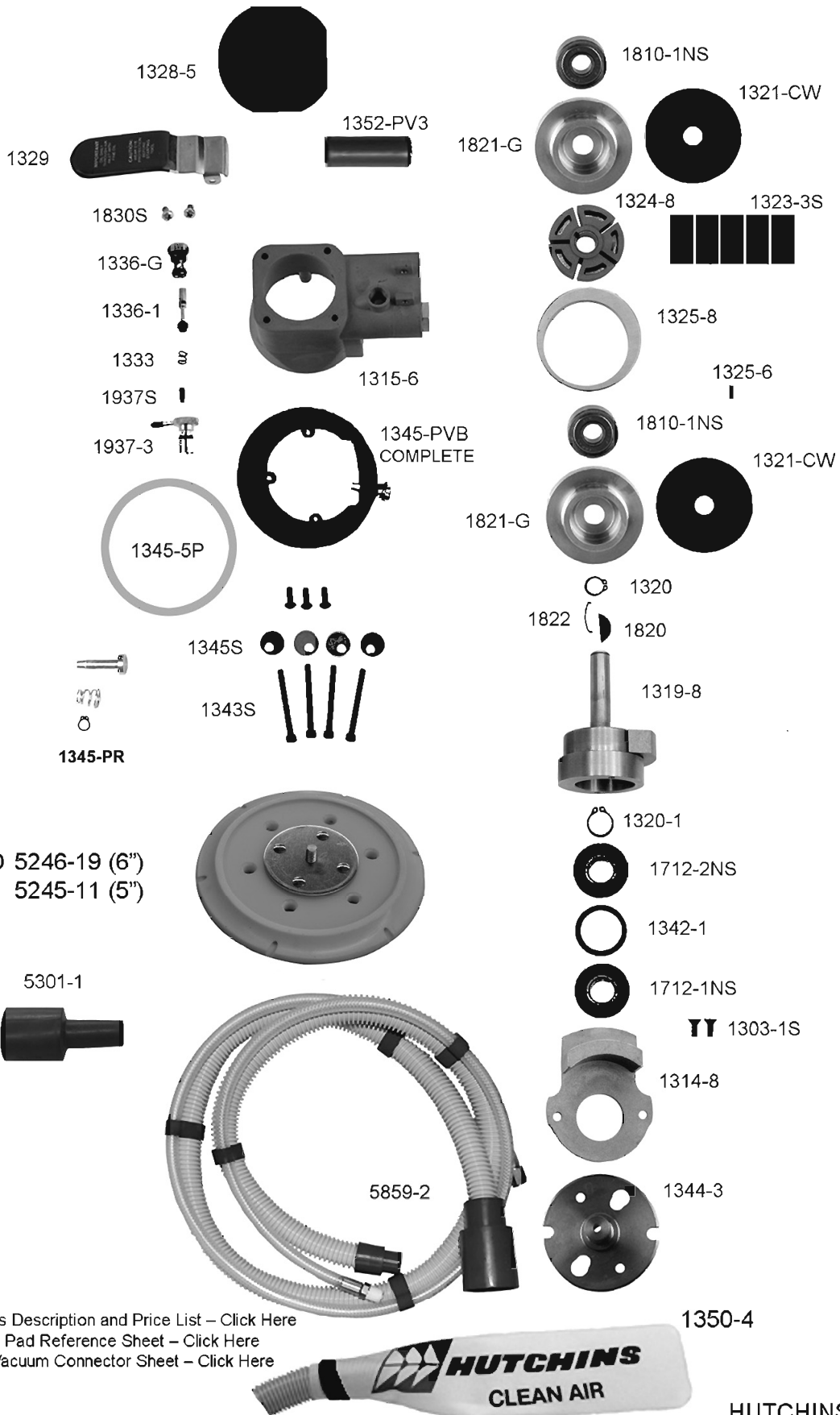

For a complete Parts Description and Price List – [Click Here](#)

For a complete Pad Reference Sheet – [Click Here](#)

For a complete Vacuum Connector Sheet – [Click Here](#)